

Article number: 12701000160700
Description: KLEE-coil 701 000 160.700
M16 Light-alloy metal

Measures

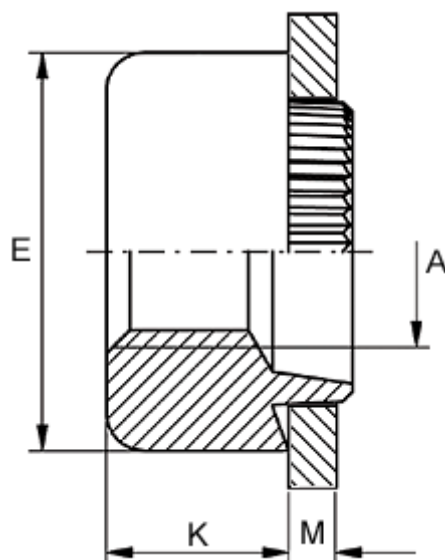

Female thread A	= M16
Height K	= 10.0
Outer diameter E	= 25.0
Plate thickness	= 0.5 to 0.6
Recommended bore diameter for extreme load	= 19.0
Recommended bore diameter for normal use	= 20.0